

Bowers & Wilkins

702 S2

SIDE

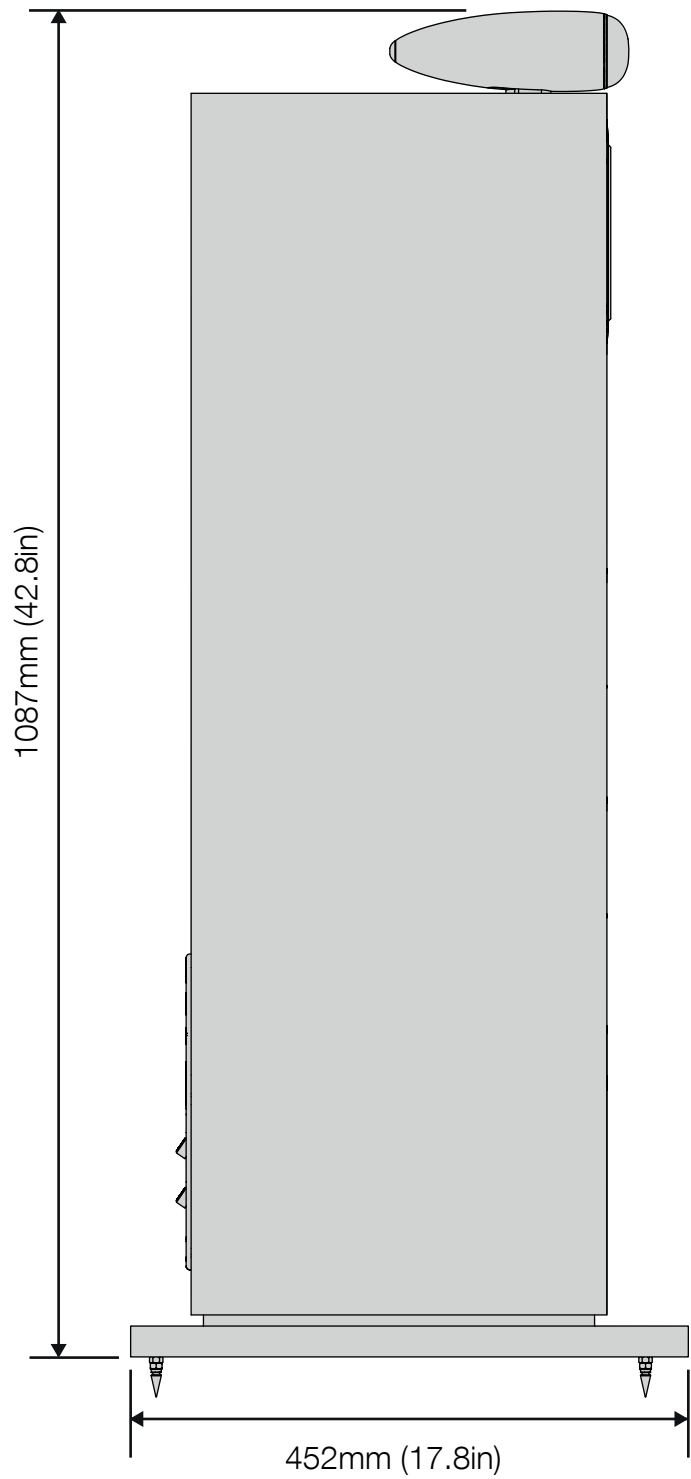

FRONT

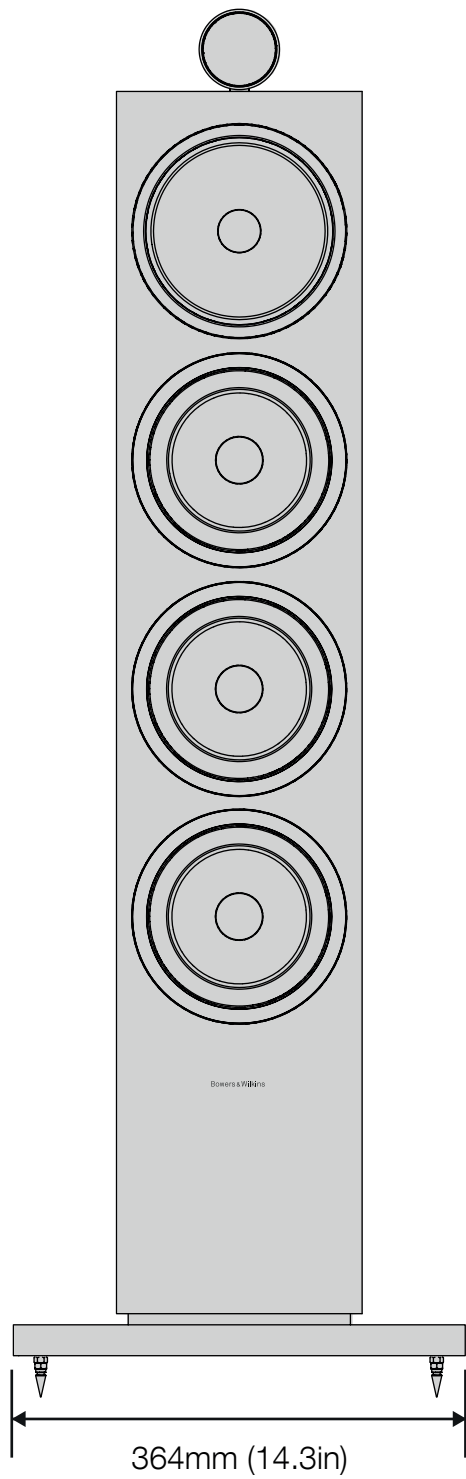

SIDE

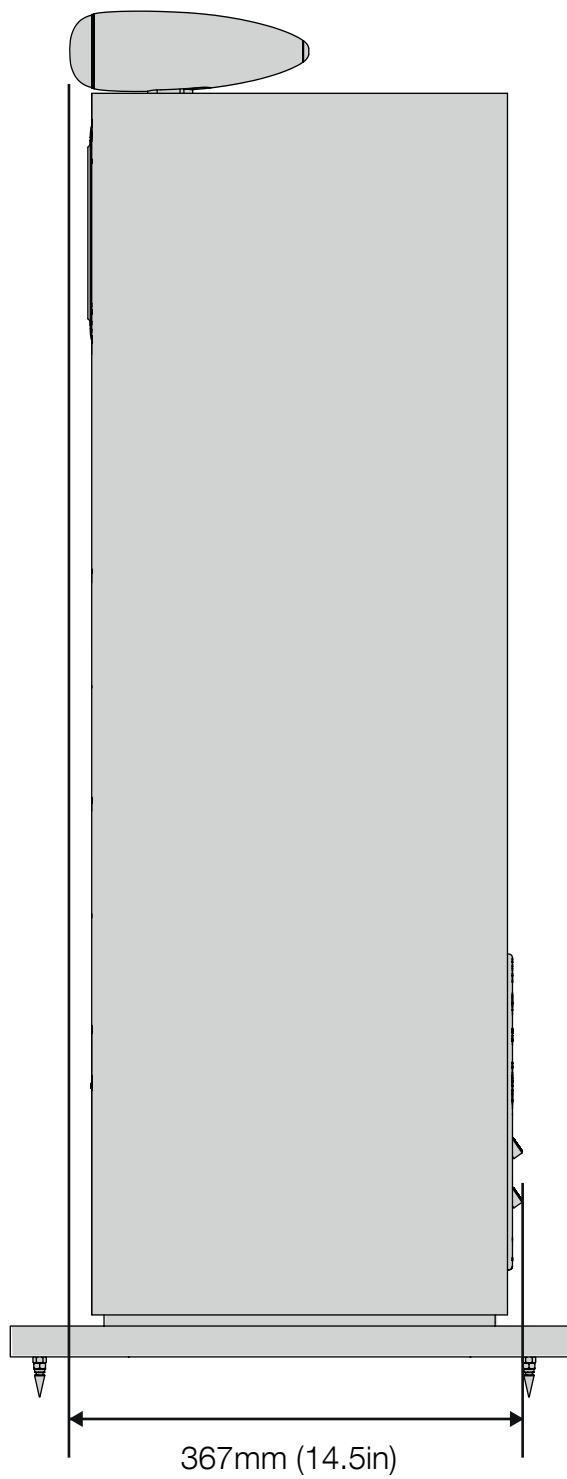

BACK

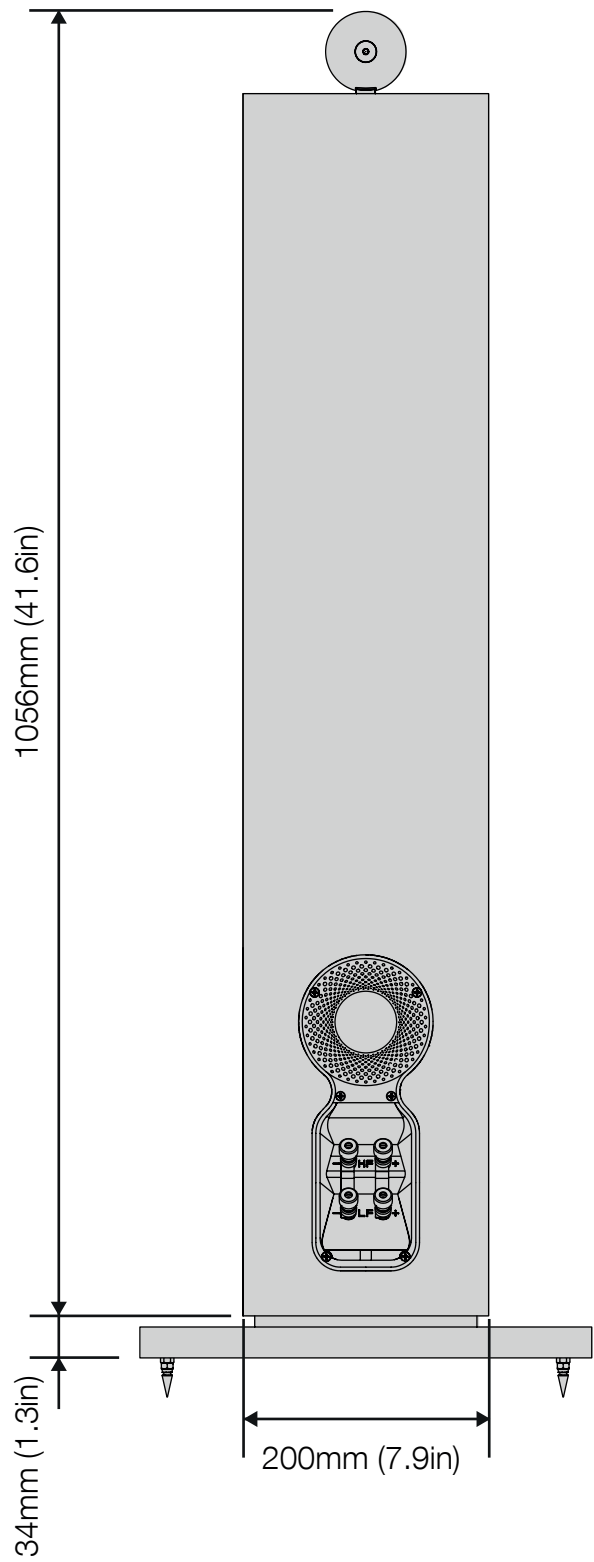

TOP

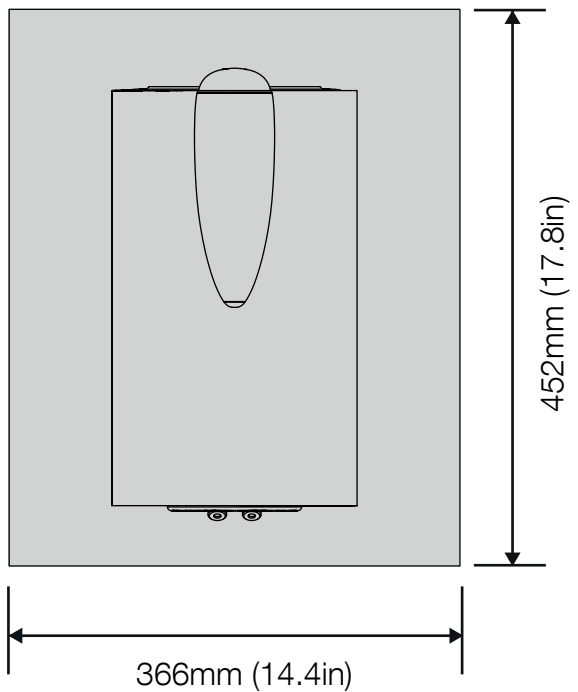

PLINTH BASE
SCREW AND FOOT ALIGNMENT

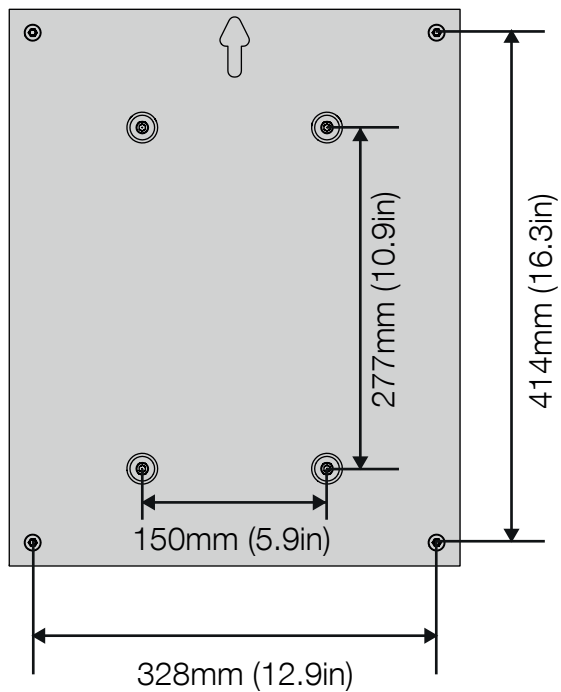

CABINET BASE
SCREW ALIGNMENT FOR PLINTH

